

100V N-Ch Power MOSFET
Feature

- ◇ High Speed Power Switching, Logic Level
- ◇ Enhanced Body diode dv/dt capability
- ◇ Enhanced Avalanche Ruggedness
- ◇ 100% UIS Tested, 100% Rg Tested
- ◇ Lead Free, Halogen Free

V_{DS}		100	V
$R_{DS(on),typ}$	$V_{GS}=10V$	6.9	mΩ
$R_{DS(on),typ}$	$V_{GS}=4.5V$	9	mΩ
$R_{DS(on),typ}$	$V_{GS}=10V$	7.1	mΩ
$R_{DS(on),typ}$	$V_{GS}=4.5V$	9.3	mΩ
I_D (Silicon Limited)		85	A

Application

- ◇ Synchronous Rectification in SMPS
- ◇ Hard Switching and High Speed Circuit
- ◇ DC/DC in Telecoms and Industrial

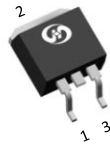
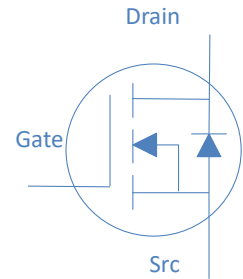
TO-263

TO-220

Part Number	Package	Marking
HGB080N10AL	TO-263	GB080N10AL
HGP080N10AL	TO-220	GP080N10AL

Absolute Maximum Ratings at $T_j=-25^{\circ}C$ (unless otherwise specified)

Parameter	Symbol	Conditions	Value	Unit
Continuous Drain Current (Silicon Limited)	I_D	$T_C=25^{\circ}C$	85	A
		$T_C=100^{\circ}C$	54	
Drain to Source Voltage	V_{DS}	-	100	V
Gate to Source Voltage	V_{GS}	-	± 20	V
Pulsed Drain Current	I_{DM}	-	260	A
Avalanche Energy, Single Pulse	E_{AS}	$L=0.4mH, T_C=25^{\circ}C$	245	mJ
Power Dissipation	P_D	$T_C=25^{\circ}C$	125	W
Operating and Storage Temperature	T_J, T_{stg}	-	-55 to 175	$^{\circ}C$

Absolute Maximum Ratings

Parameter	Symbol	Max	Unit
Thermal Resistance Junction-Ambient	$R_{\theta JA}$	50	$^{\circ}C/W$
Thermal Resistance Junction-Case	$R_{\theta JC}$	1.2	$^{\circ}C/W$

Electrical Characteristics at T_j=25°C (unless otherwise specified)
Static Characteristics

Parameter	Symbol	Conditions	Value			Unit
			min	typ	max	
Drain to Source Breakdown Voltage	$V_{(BR)DSS}$	$V_{GS}=0V, I_D=250\mu A$	100	-	-	V
Gate Threshold Voltage	$V_{GS(th)}$	$V_{GS}=V_{DS}, I_D=250\mu A$	1.4	1.7	2.4	
Zero Gate Voltage Drain Current	I_{DSS}	$V_{GS}=0V, V_{DS}=100V, T_j=25^\circ C$	-	-	1	μA
		$V_{GS}=0V, V_{DS}=100V, T_j=100^\circ C$	-	-	100	
Gate to Source Leakage Current	I_{GSS}	$V_{GS}=\pm 20V, V_{DS}=0V$	-	-	± 100	nA
Drain to Source on Resistance	$R_{DS(on)}$	$V_{GS}=10V, I_D=20A$ TO-263	-	6.9	7.7	$m\Omega$
		$V_{GS}=4.5V, I_D=10A$ TO-263	-	9	10.2	
		$V_{GS}=10V, I_D=20A$ TO-220	-	7.1	8	$m\Omega$
		$V_{GS}=4.5V, I_D=10A$ TO-220	-	9.3	10.5	
Transconductance	g_{fs}	$V_{DS}=5V, I_D=10A$	-	60	-	S
Gate Resistance	R_G	$V_{GS}=0V, V_{DS}$ Open, $f=1MHz$	-	1.3	-	Ω

Dynamic Characteristics

Input Capacitance	C_{iss}	$V_{GS}=0V, V_{DS}=50V, f=1MHz$	-	1876	-	pF
Output Capacitance	C_{oss}		-	348	-	
Reverse Transfer Capacitance	C_{rss}		-	5.6	-	
Total Gate Charge	$Q_g(10V)$	$V_{DD}=50V, I_D=20A, V_{GS}=10V$	-	32	-	nC
Total Gate Charge	$Q_g(4.5V)$		-	16	-	
Gate to Source Charge	Q_{gs}		-	6	-	
Gate to Drain (Miller) Charge	Q_{gd}		-	4	-	
Turn on Delay Time	$t_{d(on)}$	$V_{DD}=50V, I_D=20A, V_{GS}=10V, R_G=10\Omega,$	-	7	-	ns
Rise time	t_r		-	4	-	
Turn off Delay Time	$t_{d(off)}$		-	20	-	
Fall Time	t_f		-	3	-	

Reverse Diode Characteristics

Diode Forward Voltage	V_{SD}	$V_{GS}=0V, I_F=20A$	-	0.9	1.2	V
Reverse Recovery Time	t_{rr}	$V_R=50V, I_F=20A, di_F/dt=500A/\mu s$	-	40	-	ns
Reverse Recovery Charge	Q_{rr}		-	160	-	nC

Fig 1. Typical Output Characteristics

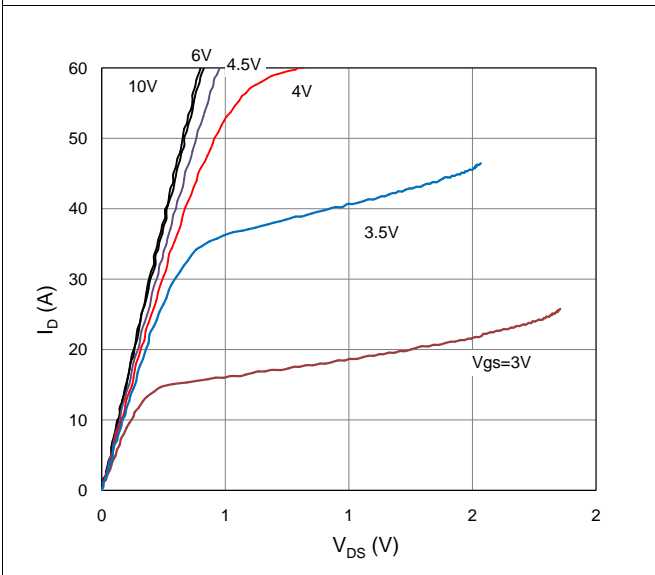

Figure 2. On-Resistance vs. Gate-Source Voltage

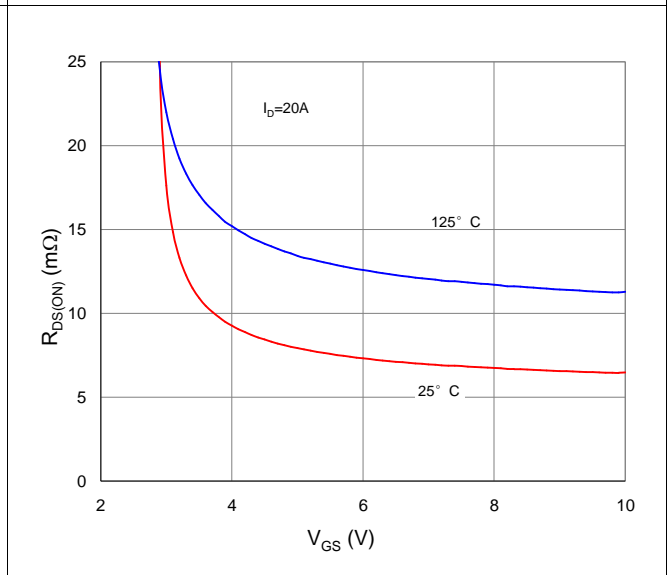

Figure 3. On-Resistance vs. Drain Current and Gate Voltage

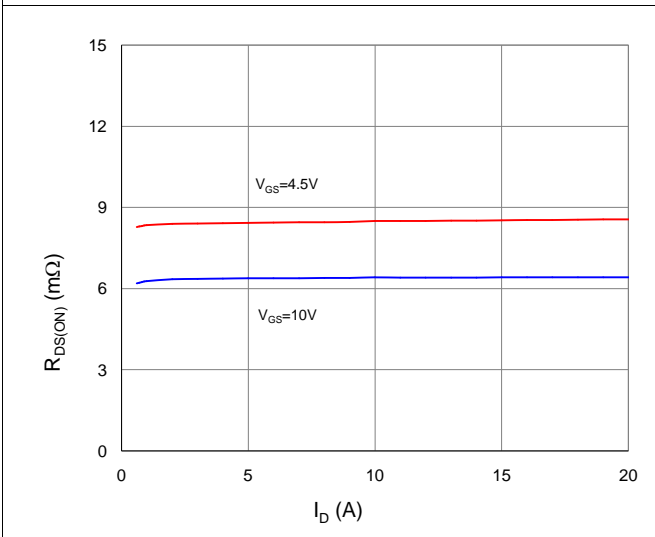

Figure 4. Normalized On-Resistance vs. Junction Temperature

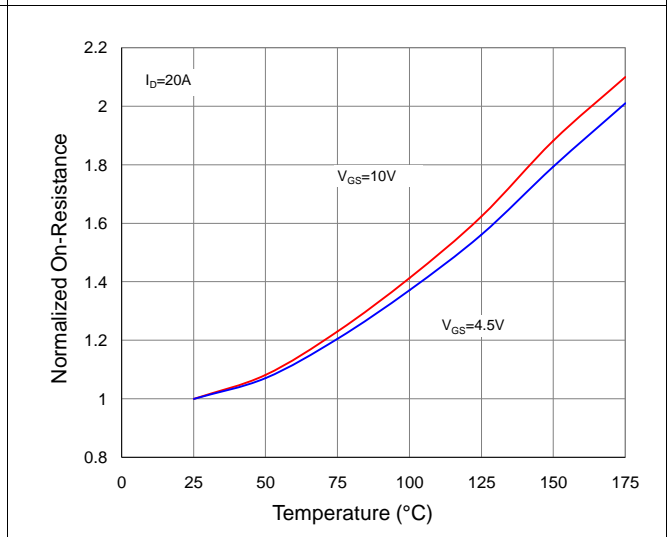

Figure 5. Typical Transfer Characteristics

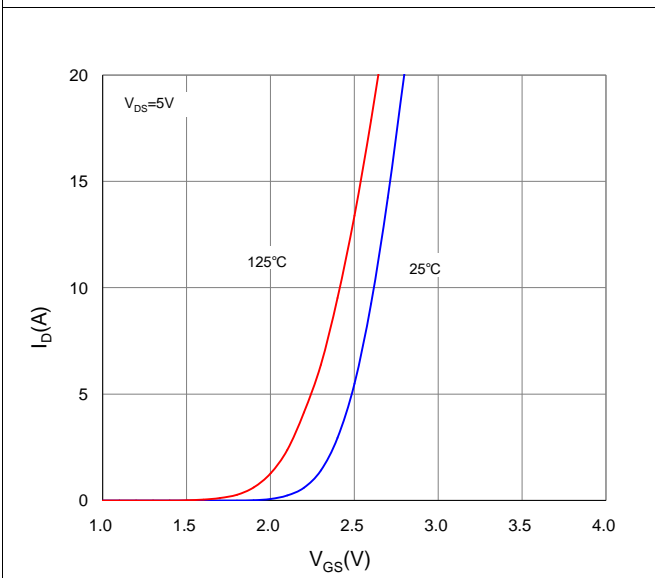

Figure 6. Typical Source-Drain Diode Forward Voltage

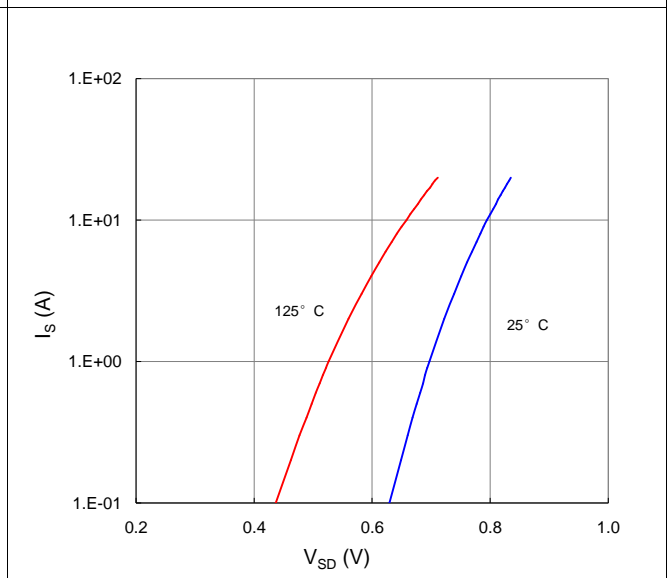

Figure 7. Typical Gate-Charge vs. Gate-to-Source Voltage

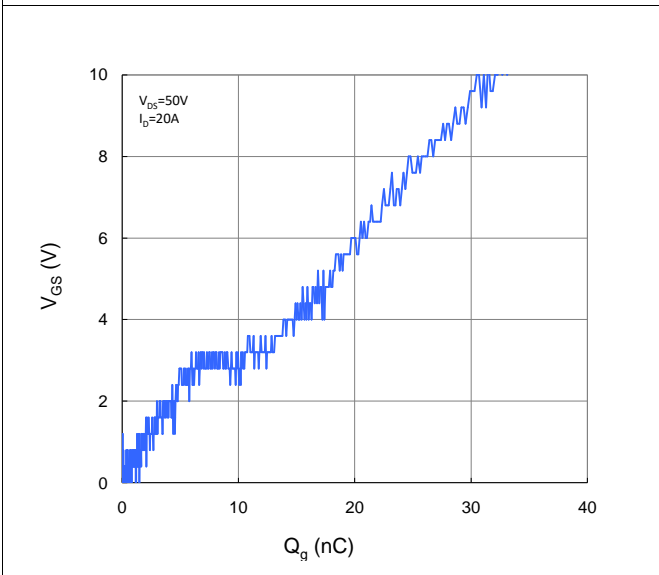

Figure 8. Typical Capacitance vs. Drain-to-Source Voltage

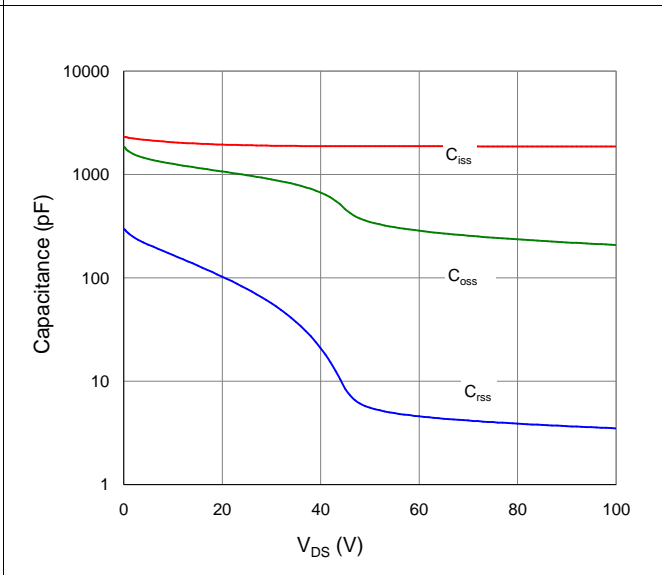

Figure 9. Maximum Safe Operating Area

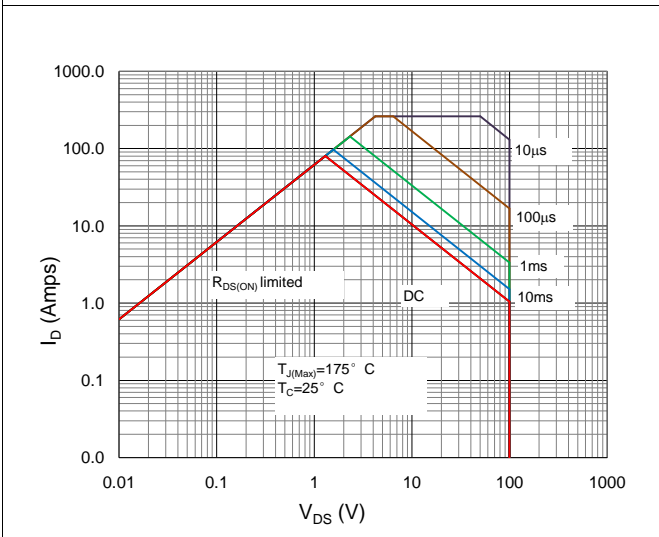

Figure 10. Maximum Drain Current vs. Case Temperature

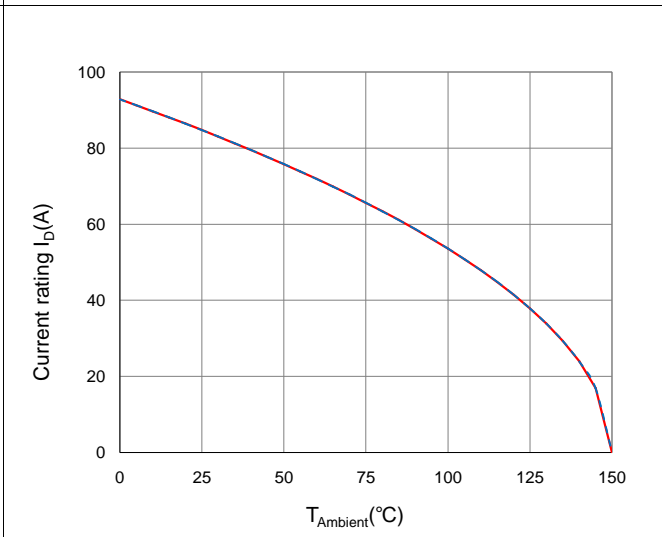
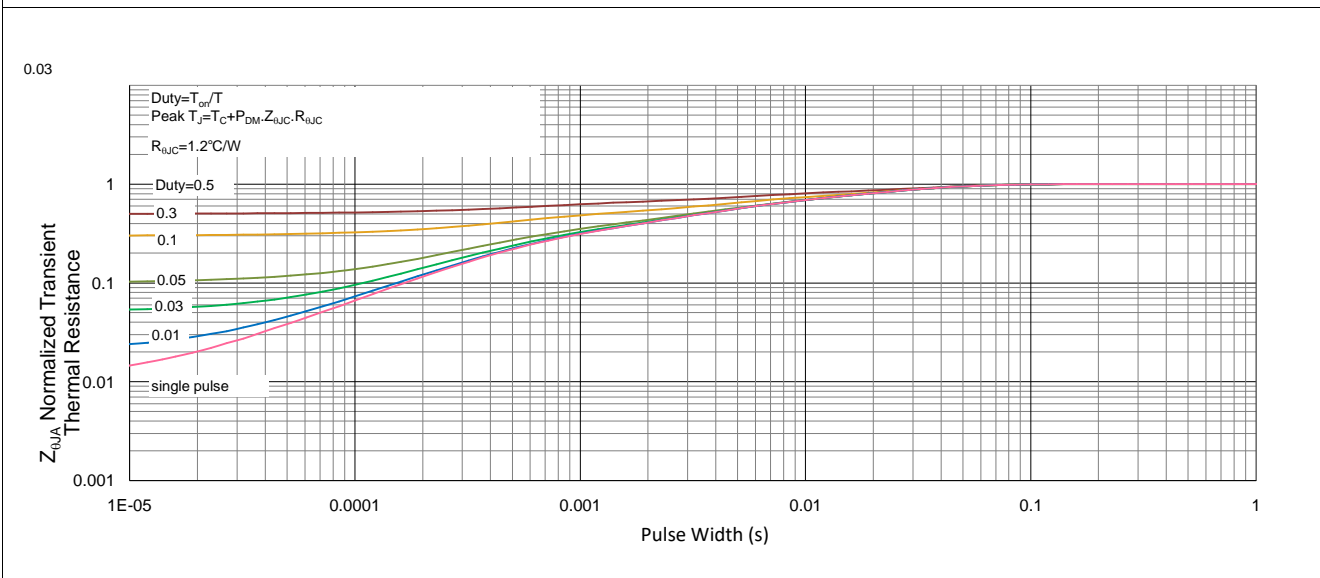
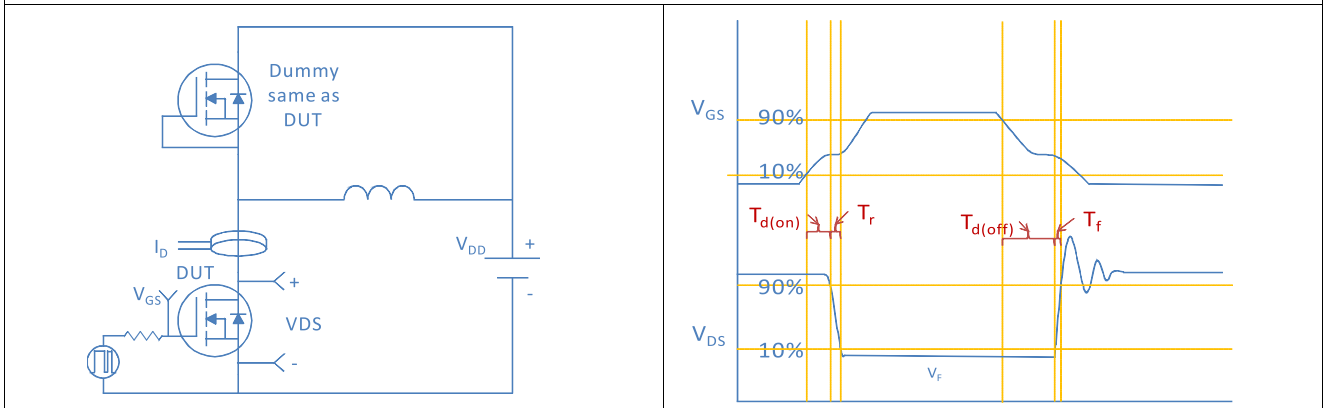

Figure 11. Normalized Maximum Transient Thermal Impedance, Junction-to-Ambient



Inductive switching Test



Gate Charge Test

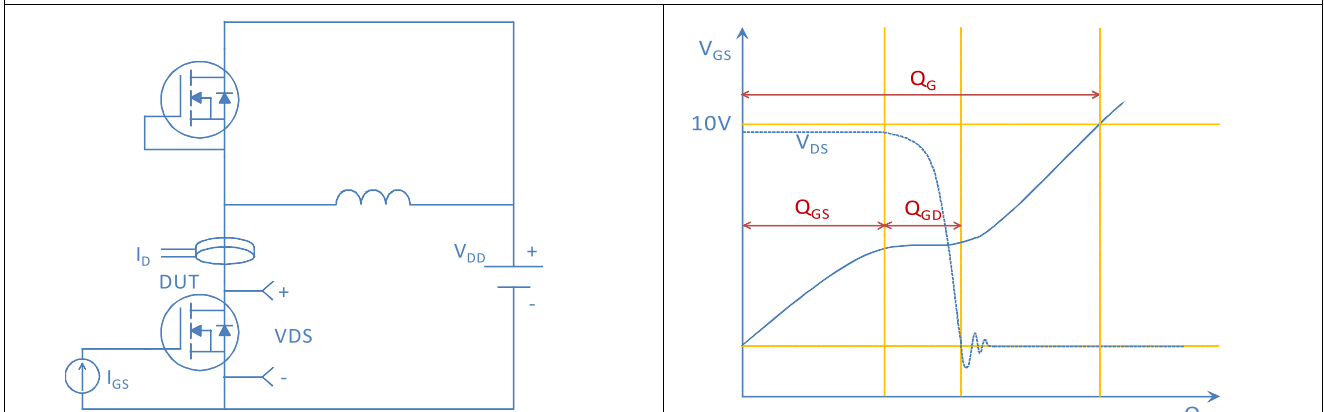

Unclamped Inductive Switching (UIS) Test

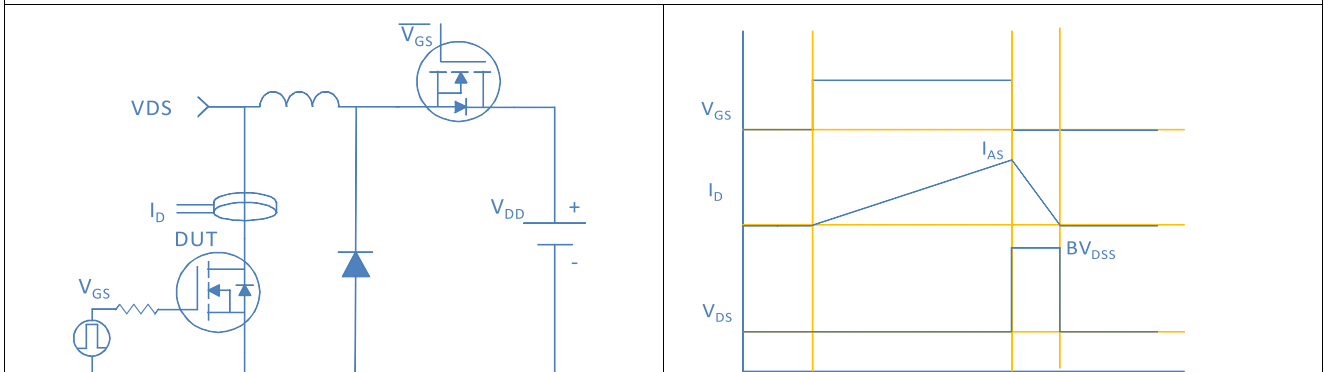

Diode Recovery Test

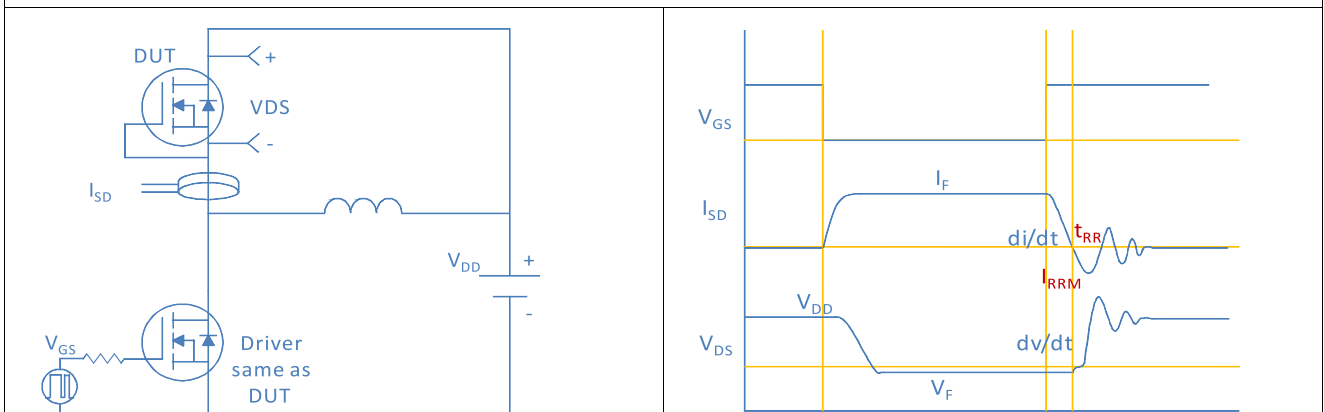

Package Outline

TO-220, 3 leads

Dimensions in mm unless otherwise specified

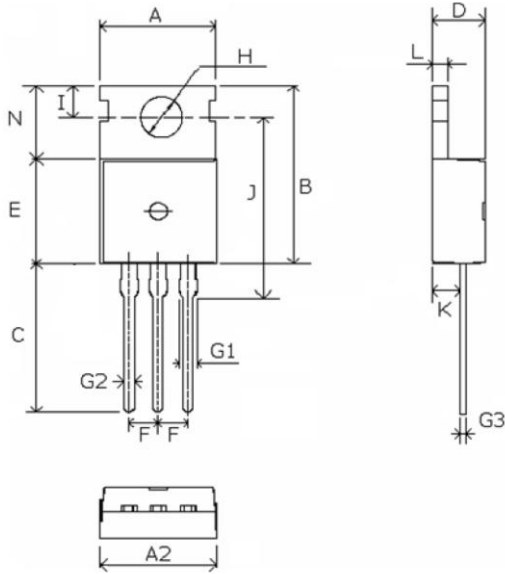

Symbol	Min	Nom	Max
A	9.66	9.97	10.28
A2	9.80	10.00	10.20
B	15.60	15.70	15.80
C	12.70	13.48	14.27
D	4.30	4.50	4.70
E	9.00	9.20	9.40
F		2.54	
G1	1.32	1.52	1.72
G2	0.70	0.82	0.95
G3	0.45	0.52	0.60
H	3.50	3.60	3.70
I	2.70	2.80	2.90
J	15.70	15.97	16.25
K	2.20	2.40	2.60
L	1.15	1.27	1.40
N	6.40	6.60	6.80

TO-263, 2 leads

Dimensions in mm unless otherwise specified

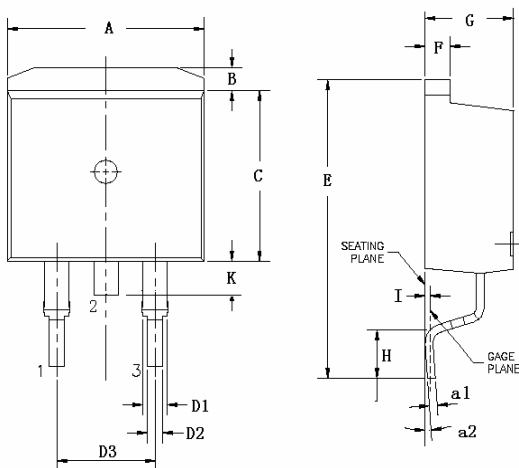

Symbol	Min	Nom	Max
A	9.66	9.97	10.28
B	1.02	1.17	1.32
C	8.59	9.00	9.40
D1	1.14	1.27	1.40
D2	0.70	0.83	0.95
D3		5.08	
E	15.09	15.24	15.39
F	1.15	1.28	1.40
G	4.30	4.50	4.70
H	2.29	2.54	2.79
I		0.25	
K	1.30	1.45	1.60
a1	0.45	0.55	0.65
a2(degree)	0°		8°